



H45N03E

N-Channel Enhancement-Mode MOSFET (25V, 45A)

Features

- $R_{DS(on)}=15m\Omega @ V_{GS}=10V, I_D=25A$
- $R_{DS(on)}=20m\Omega @ V_{GS}=4.5V, I_D=25A$
- Advanced trench process technology
- High Density Cell Design for Ultra Low On-Resistance
- Specially Designed for DC/DC Converters and Motor Drivers
- Fully Characterized Avalanche Voltage and Current
- Improved Shoot-Through FOM

H45N03E Pin Assignment

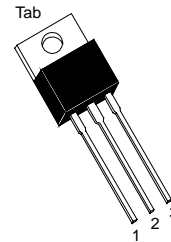

3-Lead Plastic **TO-220AB**
 Package Code: E
 Pin 1: Gate
 Pin 2 & Tab: Drain
 Pin 3: Source

Internal Schematic Diagram

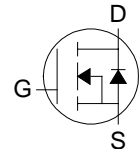

Maximum Ratings & Thermal Characteristics

($T_A=25^\circ C$ unless otherwise noted)

Parameter	Symbol	Value	Units
Drain-Source Voltage	V_{DS}	25	V
Gate-Source Voltage	V_{GS}	± 20	V
Continuous Drain Current	I_D	45	A
Pulsed Drain Current ^{*1}	I_{DM}	180	A
Maximum Power Dissipation @ $T_C=25^\circ C$	P_D	60	W
Operating Junction and Storage Temperature Range	T_J, T_{stg}	-55 to 150	$^\circ C$
Avalanche Energy with Single Pulse $I_D=35A, V_{DD}=20V, L=0.14mH$	E_{AS}	300	mJ
Junction-to-Case Thermal Resistance	$R_{\theta JC}$	2.1	$^\circ C/W$
Junction-to-Ambient Thermal Resistance(PCB mounted) ^{*2}	$R_{\theta JA}$	55	$^\circ C/W$

*1: Maximum DC current limited by the package.

*2: 1-in² 2oz Cu PCB board

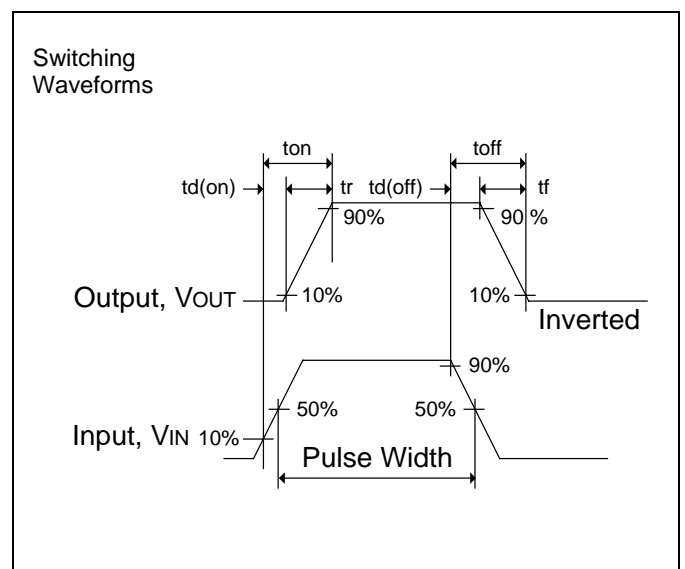
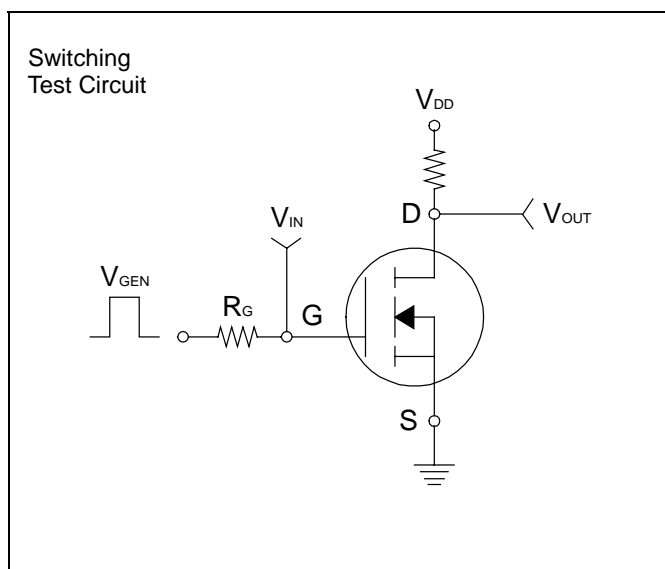



Electrical Characteristics

Characteristic	Symbol	Test Condition	Min.	Typ.	Max.	Unit
Static						
Drain-Source Breakdown Voltage	BV_{DSS}	$V_{GS}=0V, I_D=250\mu A$	25	-	-	V
Drain-Source On-State Resistance	$R_{DS(on)}$	$V_{GS}=4.5V, I_D=25A$	-	-	20	m Ω
		$V_{GS}=10V, I_D=25A$	-	-	15	
Gate Threshold Voltage	$V_{GS(th)}$	$V_{DS}=V_{GS}, I_D=250\mu A$	1	1.6	3	V
Zero Gate Voltage Drain Current	I_{DSS}	$V_{DS}=24V, V_{GS}=0V$	-	-	1	μA
Gate Body Leakage	I_{GSS}	$V_{GS}=\pm 20V, V_{DS}=0V$	-	-	± 100	nA
Gate Resistance	R_g	$V_{DS}=0V, V_{GS}=1V$ at 1MHz	-	1	-	Ω
Forward Transconductance	g_{fs}	$V_{DS}=10V, I_D=35A$	-	6	-	S
Dynamic						
Total Gate Charge	Q_g	$V_{DS}=15V, I_D=35A, V_{GS}=10V$	-	18.4	-	nC
Gate-Source Charge	Q_{gs}		-	3.57	-	
Gate-Drain Charge	Q_{gd}		-	2.9	-	
Turn-On Delay Time	$t_{d(on)}$	$V_{DD}=15V, R_L=15\Omega, I_D=1A$ $V_{GEN}=10V, R_G=24\Omega$	-	11.7	-	nS
Turn-On Rise Time	t_r		-	3.87	-	
Turn-Off Delay Time	$t_{d(off)}$		-	32.13	-	
Turn-Off Fall Time	t_f		-	5.4	-	
Input Capacitance	C_{iss}	$V_{DS}=15V, V_{GS}=0V, f=1MHz$	-	1176.3	-	pF
Output Capacitance	C_{oss}		-	268.43	-	
Reverse Transfer Capacitance	C_{rss}		-	142.67	-	
Source-Drain Diode						
Max. Diode Forward Current	I_S		-	-	35	A
Diode Forward Voltage	V_{SD}	$I_S=20A, V_{GS}=0V$	-	0.87	1.5	V

NOTE: Pulse Test: Pulse Width $\leq 300\mu s$, Duty Cycle $\leq 2\%$



Characteristics Curve

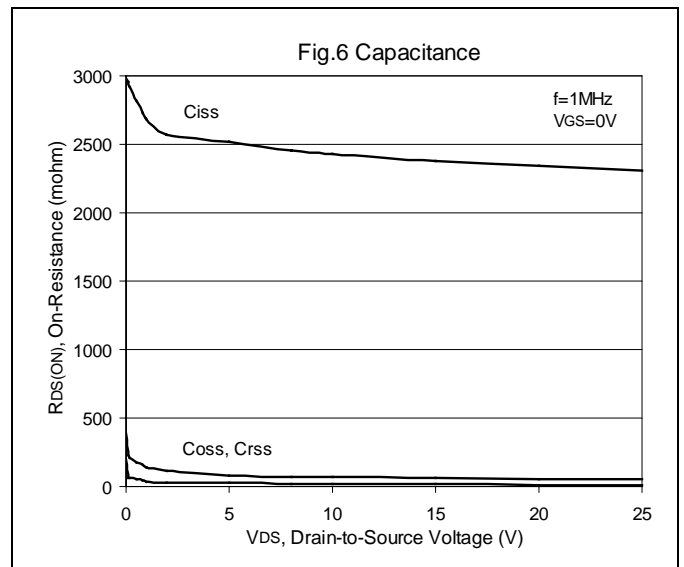
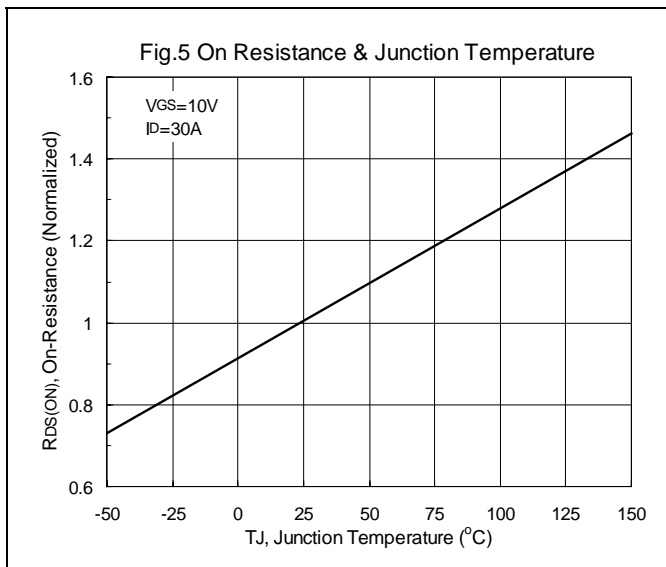
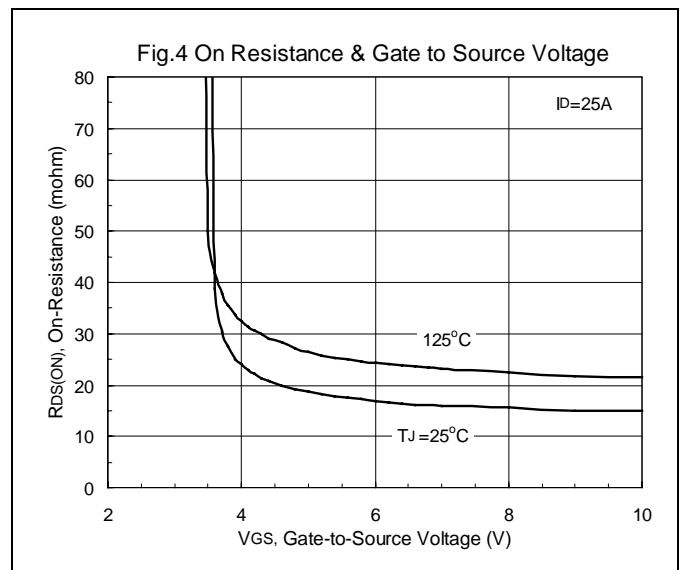
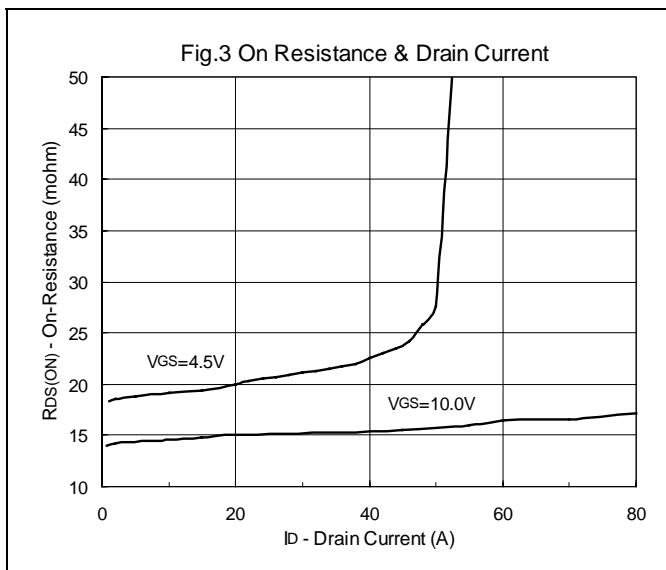
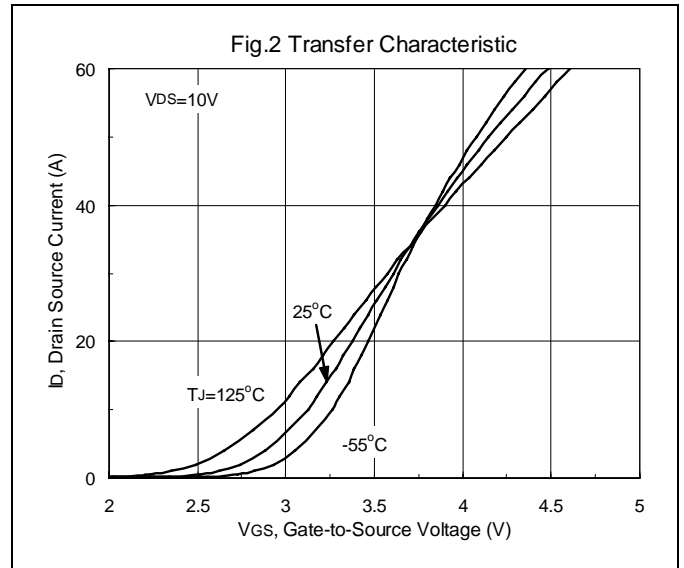
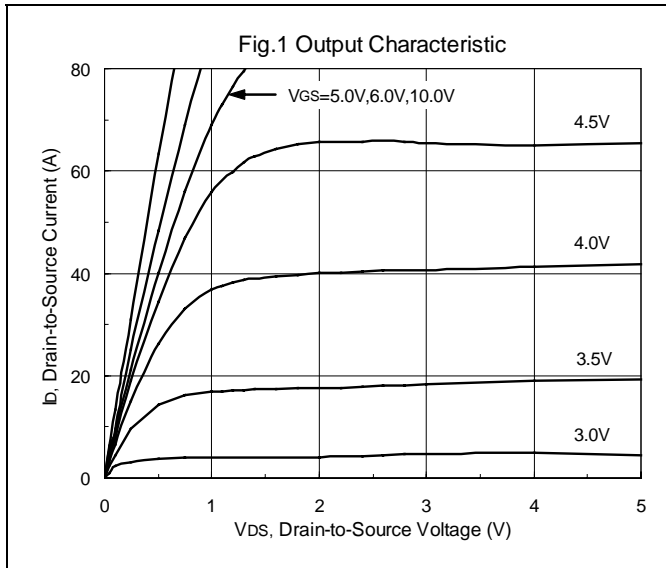



TO-220AB Dimension

3-Lead TO-220AB
Plastic Package
HSMC Package Code: E

Marking:

Pb Free Mark
 Pb-Free: "●" (Note)
 Normal: None

Date Code: 4 5 N 0 3
 Control Code: E

Note: Green label is used for pb-free packing

Pin Style: 1.Gate 2 & Tab.Drain 3.Source

Material:

- Lead solder plating: Sn60/Pb40 (Normal), Sn/3.0Ag/0.5Cu or Pure-Tin (Pb-free)
- Mold Compound: Epoxy resin family, flammability solid burning class: UL94V-0

DIM	Min.	Max.
A	5.58	7.49
B	8.38	8.90
C	4.40	4.70
D	1.15	1.39
E	0.35	0.60
F	2.03	2.92
G	9.66	10.28
H	-	*16.25
I	-	*3.83
J	3.00	4.00
K	0.75	0.95
L	2.54	3.42
M	1.14	1.40
N	-	*2.54
O	12.70	14.27
P	14.48	15.87

*: Typical, Unit: mm

Important Notice:

- All rights are reserved. Reproduction in whole or in part is prohibited without the prior written approval of HSMC.
- HSMC reserves the right to make changes to its products without notice.
- **HSMC semiconductor products are not warranted to be suitable for use in Life-Support Applications, or systems.**
- HSMC assumes no liability for any consequence of customer product design, infringement of patents, or application assistance.

Head Office And Factory:

- **Head Office** (Hi-Sincerity Microelectronics Corp.): 10F., No. 61, Sec. 2, Chung-Shan N. Rd. Taipei Taiwan R.O.C.
 Tel: 886-2-25212056 Fax: 886-2-25632712, 25368454
- **Factory 1:** No. 38, Kuang Fu S. Rd., Fu-Kou Hsin-Chu Industrial Park Hsin-Chu Taiwan. R.O.C
 Tel: 886-3-5983621~5 Fax: 886-3-5982931



Soldering Methods for HSMC's Products

1. Storage environment: Temperature=10°C~35°C Humidity=65%±15%
2. Reflow soldering of surface-mount devices

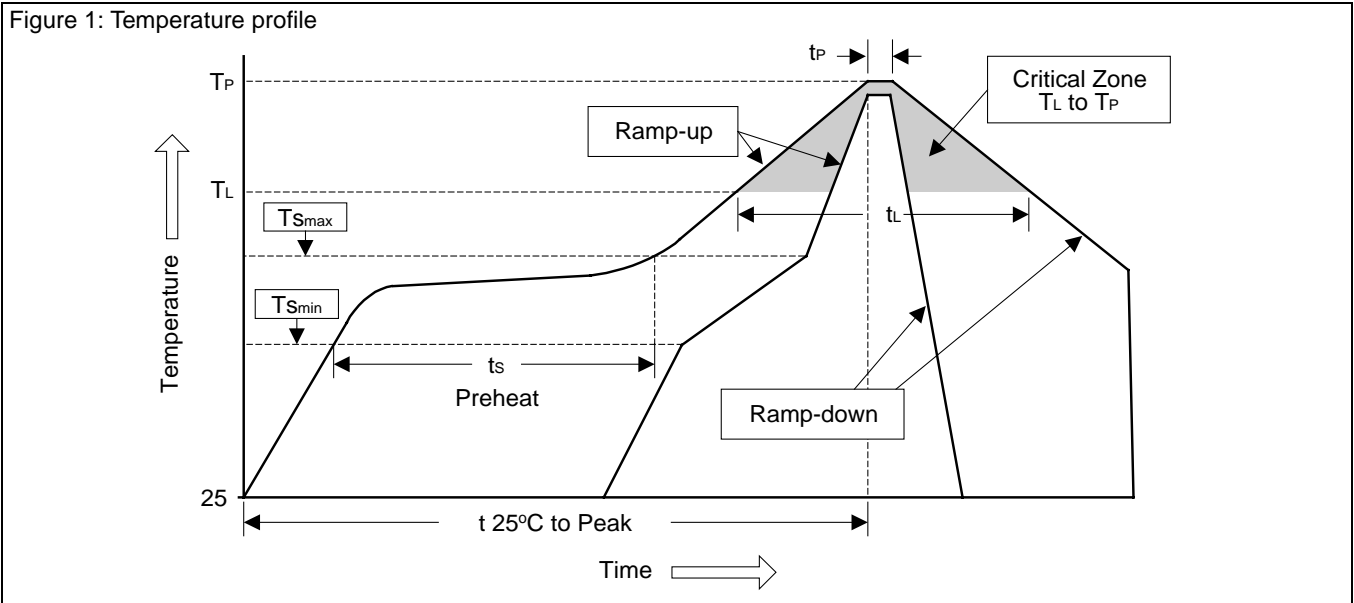

Profile Feature	Sn-Pb Eutectic Assembly	Pb-Free Assembly
Average ramp-up rate (T_L to T_P)	<3°C/sec	<3°C/sec
Preheat		
- Temperature Min (T_{Smin})	100°C	150°C
- Temperature Max (T_{Smax})	150°C	200°C
- Time (min to max) (t_s)	60~120 sec	60~180 sec
T_{Smax} to T_L		
- Ramp-up Rate	<3°C/sec	<3°C/sec
Time maintained above:		
- Temperature (T_L)	183°C	217°C
- Time (t_L)	60~150 sec	60~150 sec
Peak Temperature (T_P)	240°C +0/-5°C	260°C +0/-5°C
Time within 5°C of actual Peak Temperature (t_p)	10~30 sec	20~40 sec
Ramp-down Rate	<6°C/sec	<6°C/sec
Time 25°C to Peak Temperature	<6 minutes	<8 minutes

3. Flow (wave) soldering (solder dipping)

Products	Peak temperature	Dipping time
Pb devices.	245°C ±5°C	5sec ±1sec
Pb-Free devices.	260°C +0/-5°C	5sec ±1sec